

Standard enclosure
Series CA

| | |
|---------------------------|---------------------------------|
| Designation CA-290 | Article number 129000000 |
|---------------------------|---------------------------------|

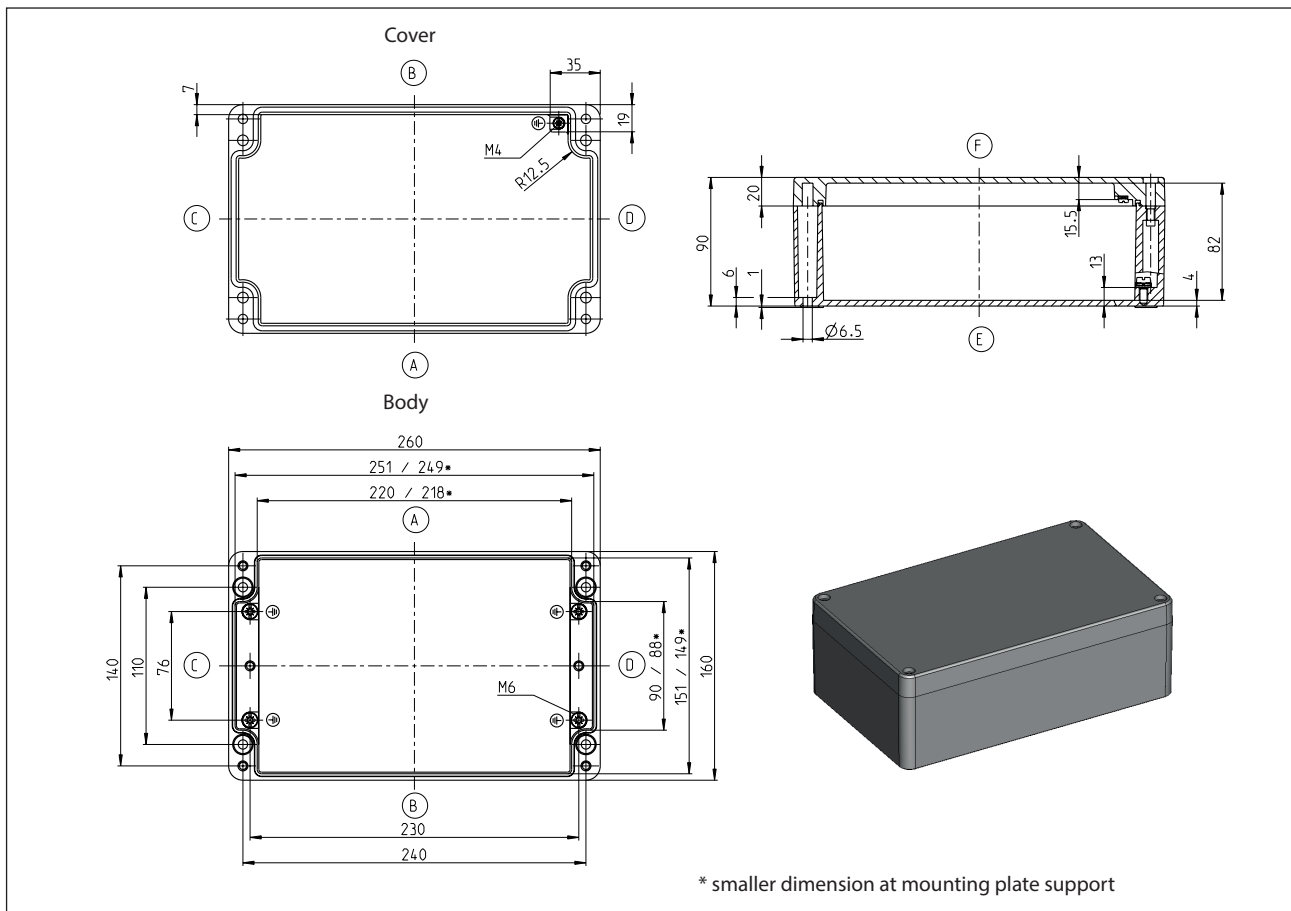

| Standard version | |
|---|--|
| Scope of supply: | |
| Base of enclosure | |
| Enclosure cover | |
| Cover screws (cross recessed head) enclosed loosely | |
| Earthing screws in the lower part and in the cover | |
| Colour RAL 7001 (silver grey) | |
| Cover gasket PUR (polyurethane) | |
| Individually packaged in foil | |

| Maximum possible number of thread (figures for identical diameter, not mixed!) | | | | | | | | |
|---|-----|-----|-----|-----|-----|-----|-----|-----|
| ISO M | M12 | M16 | M20 | M25 | M32 | M40 | M50 | M63 |
| Page A/B | 36 | 17 | 12 | 7 | 4 | 3 | 3 | 0 |
| Page C/D | 8 | 4 | 3 | 2 | 2 | 0 | 0 | 0 |

| Property chart CA-290 | | | |
|--|------------------------------------|----------------------------------|--|
| Specification | Value | According to the standard | Remark |
| General data: | | | |
| Weight | 1960 g | | |
| External dimensions | 260 x 160 x 90 | | |
| Protection classes | | | |
| IP-code | IP66 | EN 60529 | |
| IP-code | IP67 | EN 60529 | |
| IK-code | IK09 | IEC 62262 | |
| Material | | | |
| Enclosure | EN AC-ALSi12Cu1(Fe) EN AC-47100 | DIN EN 1706:05/98 | Aluminium pressure die-casting Alloy 231 |
| Screws | A2-50 | DIN EN ISO 3506-1 | Cover screws |
| Gasket | PUR (Polyurethan) | | Colour: dark grey, 2-component polyurethane foam seal |
| Toxic behaviour | halogen-free | | |
| Mechanical properties: | | | |
| Torques | | | |
| Cover screws | 2,5 Nm | | |
| Earthing screws | 2,5 Nm 2,0 Nm | | Body Cover |
| Attachment of accessories | 2,5 Nm | | for ex. mounting plates, mounting rails |
| Other mounting | 2,5 Nm | | Screw channel, External mounting brackets |
| Maximum installation weight | 2,6 kg | | |
| Thermal properties: | | | |
| Temperature range | | | |
| Enclosure without a seal | -30 °C bis +80 °C | | Standard powder-coated enclosure |
| PUR-seal | -40 °C bis +100 °C | | |
| Ambient temperature Indoor application | -5°C bis +40°C | DIN EN 62208 | On the average over 24h +35°C |
| Thermal conductivity value | 1,66 K/W | | taking account of effective dissipation loss |
| Relative humidity | | | |
| Indoor application | max. 50% bei +40°C | DIN EN 62208 | with low temperatures also higher (for ex. 90% at +20°C) |
| Storage temperature | -20°C bis +60°C | | |
| Chemical properties: | | | |
| Corrosion resistance | Severity level A | DIN EN 62208/9.13.2.1 | IEC 60068-2-30 and IEC 60068-2-11 |
| Corrosion resistance | Severity level B | DIN EN 62208/9.12.2.1 | IEC 60068-2-30 and IEC 60068-2-11 |
| Resistance lists for enclosure materials and seals see catalog | | | |

| Property chart CA-290 | | | |
|------------------------------------|--------------------------------------|----------------------------------|--|
| Specification | Value | According to the standard | Remark |
| Electrical characteristics: | | | |
| Protection class | I | EN 61140 / VDE 0140-1 |  Protection by protective conductor |
| Rated voltage | max. 1000 V (AC) max. 1500 V (DC) | | |
| More details: | | | |
| General tolerance | GTA 13/5 | DIN 1688 | Cast part tolerances |
| General tolerance | mH | ISO 2768 | Machining tolerances |
| Product standard | Yes | DIN EN 62208 | Empty enclosures for low-voltage switchgear assemblies |
| Approvals | | | |
| c UL us | Yes | UL508A / C22.2 | Typ 1, 4, 4x, 12, 13 |
| Compliances | | | |
| RoHs | compliant | Directive 2011/65/EU | |
| CE label | compliant | EG-Nr. 765/2008 | |
| Low-Voltage-Directive No.: | 2014/35/EU | | |

Other versions / Accessories

The following information is not a standard. Approvals, compliances and protection classes of these versions upon request.

| Other versions CA-290 | |
|--|----------------|
| Description of the modification compared with the standard version | Article number |
| HF seal and cover screws | 1290008000 |
| Unwashed, not painted, loose accessories | 1290011000 |
| CR gasket | upon request |
| UV-resistant powder (outdoor installation) | upon request |
| Packed in cartons (screwed-in cover screws) | upon request |

| Accessories / as individual parts or as assembly set | |
|---|----------------|
| Description of the modification compared with the standard version | Article number |
| Mounting plate | 9511096000 |
| Mounting rail TS 15 | - |
| Mounting rail TS 32 | 9821008000 |
| Mounting rail TS 35 | 9822011000 |
| Earthing rail | 9810010000 |
| External mounting brackets | 9824024000 |
| External articulated hinges | 9801047000 |
| Internal articulated hinges with cover guide (mechanical machining of the enclosure required) | 9801030000 |

| Alternative seals | | | |
|----------------------------|--------------------|---------------------------|--------------|
| Specification | Value | According to the standard | Remark |
| Thermal properties: | | | |
| CR gasket | -30 °C bis +80 °C | | IP66 |
| Silicone foam seal | -60 °C bis +130 °C | | IP66 / IP67 |
| Silicone complete seal | -60 °C bis +200 °C | | IP66 / IP67 |
| EPDM seal | -35 °C bis +100 °C | | IP66 |
| HF seal | -55 °C bis +125 °C | | upon request |